

Metric User's Manual

 **LASER[™]
TECHNOLOGY**
Measurably Superior[™]

LTI 20/20 TruSpeed Metric User's Manual

Part Number 0444909

Copyright Notice

Information in this document is subject to change without notice and does not represent a commitment on the part of Laser Technology, Inc. No part of this manual may be reproduced in any form or by any means, electronic or mechanical, including photocopying, recording, or information storage and retrieval systems, for any purpose other than the purchaser's personal use, without the express written consent of Laser Technology, Inc.

Copyright © Laser Technology, Inc., 2008. All rights reserved.
Printed in the United States of America
First Edition: April 2008

Trademarks

TruSpeed is a trademark of Laser Technology, Inc.
All other trademarks are the property of their respective owners.

Patents

This product is covered by pending patent applications and/or one or more of the following issued patents: 6,559,404
6,624,696
6,715,045

LTI Contact Information

Laser Technology, Inc.
7070 S. Tucson Way
Centennial, CO 80112 USA

Phone: 1-303-649-1000
Fax: 1-303-649-9710
Web Site: www.lasertech.com

Warranty Validation Card

Warranty Validation Card - International

In order to activate your one year Limited Warranty, please fill out this warranty information card, and either mail or fax it to Laser Technology, Inc. within 30 days. Receipt of a warranty validation card will activate your Limited Warranty and allow Laser Technology to contact you directly when hardware and software upgrades become available.

Your unit is not covered under the Laser Technology Limited Warranty until it is registered.

Company: _____
Contact Name: _____ Position: _____
Address: _____

Phone: _____ Fax: _____
Email: _____

LTI 20-20 TruSpeed Serial Number: _____ Purchase Date: _____
Purchased From: _____

Return To:
Laser Technology, Inc. 7070 South Tucson Way, Centennial, CO 80112 USA
Phone: (303) 649-1000, Fax: (303) 649-9710, Web Site: www.lasertech.com

LTI 20/20 TruSpeed Metric User's Manual Table of Contents

Section #1 - Getting Started	3
Unpacking Your TruSpeed	3
Important Safety Information	3
About the TruSpeed	4
Sensors	5
LCD Screen	5
Serial Port	5
Sighting Scope	5
Buttons on the Keypad	6
Optional Shoulder Stock	7
Attaching the Shoulder Stock	7
Removing the Shoulder Stock	7
Installing / Removing the Batteries	8
Removing the Battery Tube from the Handle	8
Inserting the Batteries in Battery Tube	8
Re-inserting the Battery Tube into the Handle	8
Battery Voltage Level	9
Powering ON the TruSpeed	10
Powering OFF the TruSpeed	10
Understanding the Display Indicators	11
Miscellaneous Display Features	12
Adjusting the Aiming Reticule's Intensity	13
Restoring Factory Default Settings	13
Listening to the TruSpeed	14
Understanding Error Conditions	15
Error Codes	15
RFI Considerations	15
Section #2 - Speed Measurements	16
Taking a Sample Measurement	17
Choosing a Roadside Location	17
Line of Sight	18
The Cosine Effect	18
Measuring a Moving Vehicle	20
Using the Weather Mode	21
Using the Continuous Mode	22
Optional Jam Detect Feature	23
Optional Local Speed Limit Edit	24

LASER TECHNOLOGY, INC.
7070 S TUCSON WAY
CENTENNIAL, CO 80112

PLEASE AFFIX
PROPER
INTERNATIONAL
POSTAGE HERE

Section #3 - Test Mode and Instrument Tests	25
Display Integrity Test	25
Scope Alignment Test	26
Instrument Confidence Checks	27
Fixed Distance Zero Velocity Test	28
Delta Distance Test	29
Instrument Self Test	31
Optional Local Speed Limit Edit	32
Model and Firmware Version Number Display	33
Serial Number Display	33
Section #4 - Maintenance	34
Section #5 - Serial Data Interface	35
Data Format	35
Format Parameters	35
Download Instructions	35
Remote Trigger	35
Requests	36
Firmware Version ID Request	36
Example Version ID Messages	36
Serial Number Request	36
Example Version ID Messages	36
Speed / Range Data Message Format	37
Example Speed/Range Messages	37
Section #6 - Specifications	38
Section #7 - Troubleshooting Tips	39
Section #8 - Glossary	40
Index	41

Section #1 - Getting Started

Unpacking Your TruSpeed

When you receive your TruSpeed, check to make sure that you received everything that you ordered, and that it all arrived undamaged.

TruSpeed Basic Package:

- TruSpeed Instrument with Polarizing Filter
- Two C-Cell Batteries
- Metric User's Manual

Available Features:

- Jam Detect
- Long Range
- Local Speed Limit Edit

Available Accessories

- Carrying Case - hard
- Carrying Case - soft
- Shoulder Stock
- Monopod
- Tripod
- TruSpeed Yoke
(includes adapter for monopod/tripod mounting)
- TruSpeed Battery Eliminator

Important Safety Information

Avoid staring directly at the laser beam for prolonged periods.

- The TruSpeed is designed to meet FDA eye safety requirements and is classified as eye-safe to Class 1 limits, which means that virtually no hazard is associated with directly viewing the laser output under normal conditions. As with any laser device, reasonable precautions should be taken in its operation. It is recommended that you avoid staring into the transmit lens while firing the laser. The use of optical instruments with this product may increase eye hazard.

Never attempt to view the sun through the scope.

- Looking at sun through the scope may permanently damage your eyes.

Never point the instrument directly at the sun.

- Exposing the lens system to direct sunlight, even for a brief period, may permanently damage the laser transmitter.

Do not operate the instrument in extreme temperatures.

- TruSpeed components are rated for a temperature range of -30° C to +60° C. Do not operate the instrument in temperatures outside that range.

About the TruSpeed

Laser Technology's LTI 20/20 TruSpeed is part of the Laser Technology family of handheld laser speed and ranging devices. Compared to our other laser speed measurement products, the TruSpeed includes:

- Simplified menus and options.
- Built-in Weather Mode: an alternate speed measurement mode. It is a simplified gating option. This factory-defined gate ensures that targets are beyond the range where rain and snow can affect the laser's ability to capture a speed reading.
- Continuous Mode: an alternate speed measurement mode. It displays one speed reading after another until you release the TRIGGER.
- Liquid Crystal Display (LCD) screen for instant access to measurements and options.
- Sighting scope with in-scope aiming reticle and in-scope speed measurement display.
- Seven-button keypad that provides quick and easy access to the instrument functions.
- Sounds and visual indicators that ensure confidence of positive target acquisition.
- Serial data output port for easy connection to a data collector or remote computer.

Figure #1 shows the TruSpeed's front and rear panels.

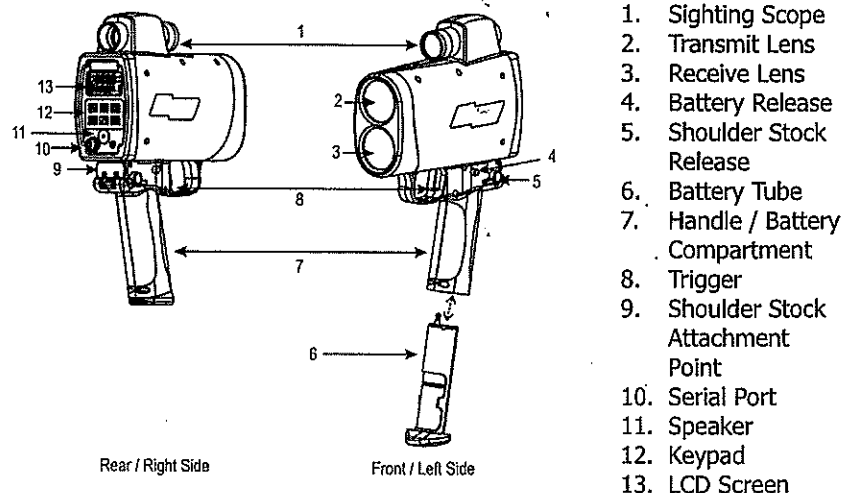

Figure #1

Sensors

The TruSpeed has two lenses on the front panel. The top lens transmits the infrared laser signals. The bottom lens receives the signals back from the target and feeds signal information to the internal circuitry.

The internal circuitry consists of a laser range sensor and timing, analysis, computation, and display circuits. The TruSpeed determines distance through its laser range sensor, by measuring the time of flight of short pulses of infrared light. The TruSpeed has a broad spectrum of sensitivity and can work with both reflective and non-reflective targets. The maximum measurement distance varies with target and environmental conditions.

- The absolute maximum is about 650 meters.
- Long Range (*optional feature*) absolute maximum is about 1,200 meters.

LCD Screen

The LCD Screen displays menu items, option indicators, error codes, and speed measurement results.

Serial Port

Your TruSpeed includes a serial port located on the rear panel. The serial port allows you to connect the instrument to a data collector or remote computer. For information about the Serial Data Interface, see page 35.

Sighting Scope

Mounted on top of the TruSpeed is a single-power sighting scope.

- The polarizing light filter is adjustable to optimize viewing contrast. Figure #2 shows the polarizing light filter's adjustment ring.
- The in-scope aiming reticle helps you aim accurately to the target. Figure #3 shows reticle. This reticle represents the size of the laser beam.
- In-scope speed measurement display.

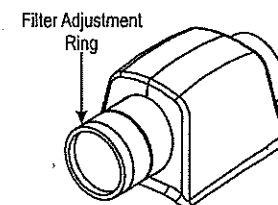

Figure #2







- You can vary the intensity of the aiming reticle to account for different lighting conditions. For more information, see page 13.



Figure #3

Buttons on the Keypad

The TruSpeed has a 7-button keypad located on the rear panel of the instrument. The buttons provide easy access to the instrument functions. The table below lists the buttons and the functions of each.

Button	Name	Function
	Speed Mode	Activates the instrument's speed measurement mode. Speed Limit Edit Function: Accepts the value that appears on the screen.
	Weather Mode	Activates an alternate speed measurement mode: simplified gating option. Targets must be at a distance greater than 61 meters. Speed Limit Edit Function: Adds 1 to the value of the flashing digit.
	Continuous Mode	Activates an alternate speed measurement mode: allows you to obtain successive speed readings on a target vehicle. Speed Limit Edit Function: (1) Activates the edit function. The right-most digit will be flashing. (2) Press to edit the digit to the left of the flashing digit.
	Backlight	Toggles the display backlight ON/OFF.
	Test Mode	Activates the instrument's Test Mode: allows you to verify the TruSpeed's mechanics. Speed Limit Edit Function: Subtracts 1 from the value of the flashing digit.
	Brightness Control	Varies the intensity of the in-scope aiming reticle.
	Power ON/OFF	Press and release to power ON the instrument. Press-and-Hold for approximately 3 seconds to power OFF the instrument.

Optional Shoulder Stock

The Shoulder Stock is available for purchase as an accessory item. The Shoulder Stock helps stabilize the TruSpeed while capturing speed measurements and is designed for either left-handed or right-handed use.

Attaching the Shoulder Stock

1. Flip the Shoulder Stock Release toward the front of the TruSpeed.
2. Align the pronged-end of the Shoulder Stock with the Shoulder Stock Attachment Point as shown in Figure #4.
3. Slide the Shoulder Stock straight into the two holes.
4. Flip the Shoulder Stock Release toward the rear of the TruSpeed to secure the Shoulder Stock.

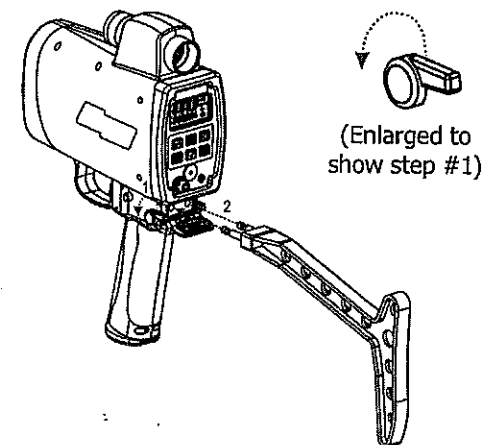

Figure #4

Removing the Shoulder Stock

1. Turn the Shoulder Stock Release toward the front of the TruSpeed. Continue to hold the Shoulder Stock Release in this position.
2. Pull the Shoulder Stock straight toward you.

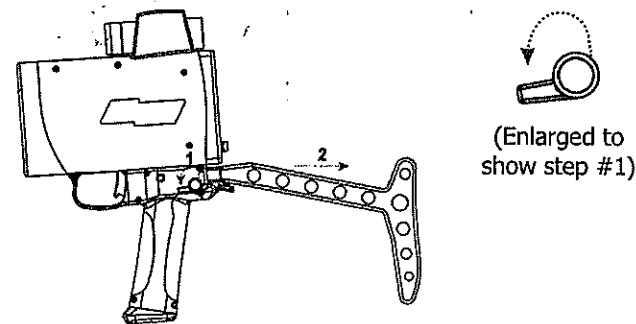

Figure #5

Installing / Removing the Batteries

Two C cell batteries are required to power the TruSpeed. The batteries are located in the Battery Tube inside the Handle.

Removing the Battery Tube from the Handle

1. Hold the TruSpeed with one hand and hold the bottom of the Handle with your other hand.
2. Press the Battery Release, the black button on both sides of the TruSpeed, just behind the TRIGGER.
3. Slide the Battery Tube out of the Battery Compartment.

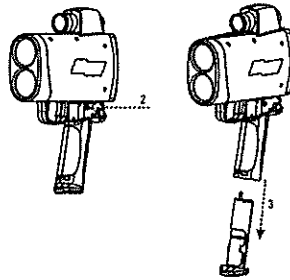

Figure #6

Inserting the Batteries in Battery Tube

1. With the positive end pointing toward the bottom of the Battery Tube, align the battery with the opening of the Battery Tube as shown in Figure #7A and B.
2. Insert the battery into the Battery Tube and slide the battery to the top of the tube.
3. Position the second battery as described in step #1 and insert the battery into the tube as shown in Figure #7C.

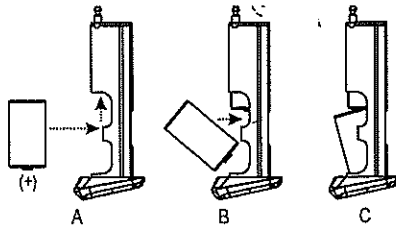

Figure #7

i To remove the batteries from the Battery Tube, just reverse the above instructions.

Re-inserting the Battery Tube into the Handle

The Battery Compartment is designed so the Battery Tube only fits one way.

1. Align the notched edges of the Battery Tube with those of the Battery Compartment.
2. Slide the tube into the compartment until it locks into place.

Battery Voltage Level

The TruSpeed continuously monitors its power source. LTI has defined an acceptable battery voltage range to ensure that the instrument has sufficient battery voltage to guarantee correct operation.

Appearance of the Battery Icon	Explanation
	3 segments are lit and the display is steady. The estimated battery life is between 67% and 100%.
	2 segments are lit and the display is steady. The estimated battery life is between 34% and 66%.
	1 segment is lit and the display is flashing. The estimated battery life is between 33% and 11%.
	Only the outline is lit, no segments are lit and the display is steady. The estimated battery life is approximately 10%, and the instrument is still operating normally. You should replace the batteries as soon as possible.
	Only the outline is lit, no segments are lit and the display is flashing. "bAtt" appears in the upper display and "CHAng" appears in the lower display. All system operation will be locked out and the only button that will work is the button, which you can use to power OFF the TruSpeed.

Powering ON the TruSpeed



1. Press the TRIGGER or the  button. Briefly, the instrument's microcontroller will perform the Self Test.



Figure #8

- If all tests prove positive, "PASS" appears briefly in the upper display and "SELF" appears in the lower display as Figure #8 shows. Then the Speed Mode will be active and the Speed Measurement Screen will be displayed (page 16).
- If all tests do not prove positive, the appropriate error code will appear in the upper display (page 15).

 If the instrument fails the Self Test:

1. Press the  button to power OFF the TruSpeed.
2. Press the  button to once again power ON the TruSpeed and repeat the Self Test.
 - If the error repeats and you need assistance, contact LTI. See the inside front cover for LTI contact information.

Powering OFF the TruSpeed

1. Press and hold the  button for approximately 3 seconds.

-  To help save its batteries, the TruSpeed has a factory-defined power OFF interval. The instrument will automatically power OFF if there is no activity for a period of 15 minutes. Instrument activity includes any button presses.

Understanding the Display Indicators

Figure #9 shows the LCD Screen. The table below lists the display indicators and the function of each. These are presented in order of location on the screen, from left to right starting in the upper left corner.



Figure #9

Display Indicator	Function	Explanation
★	Display Backlight	<i>Visible:</i> The LED backlight is ON.
		<i>Not Visible:</i> The LED backlight is OFF.
0000	Upper Display	Provides access to speed measurements and messages.
MPH km/h	Speed Units	MPH: Miles per Hour. km/h: Kilometers per Hour.
✓	Test Mode	The instrument's Test Mode is active (page 25).
○	Continuous Mode	The instrument's Continuous Mode is active (page 22).
☂	Weather Mode	The instrument's Weather Mode is active (page 21).
0000	Lower Display	Provides access to range measurements and messages.
F m	Range Units	F: Feet. m: Meters.
★	Laser Fire	The instrument's laser is firing.
	Battery	Identifies the approximate current battery voltage. The indicator shown here represents 100%-67% battery life (page 9).



Miscellaneous Display Features

The table below lists the miscellaneous display features.

Display Feature	Explanation	Refer to Pages
bAtt CHAng	You must replace the batteries. Appears in the upper and lower displays.	9
br xx	The in-scope aiming reticle's intensity setting. Appears in the upper display.	13
-d1-	Delta Distance Test - Distance #1. Appears in the upper display.	30
-d2-	Delta Distance Test - Distance #2. Appears in the upper display.	30
dEF CLEAR	The factory default settings have been restored. Appears in the upper and lower displays.	13
E xx	Error Code. An error condition has occurred during a speed measurement attempt or in the system hardware. Appears in the upper display.	15
PASS	Successful completion of the instrument Self Test. Appears in the upper display.	31
SELF	The instrument is performing (or has performed) the instrument Self Test. Appears in the lower display.	31
SN	Serial Number. "SN" appears in the upper display. The serial number associated with the unit. Appears in the lower display.	33
SpdLt	When the TruSpeed includes the optional Local Speed Limit Edit feature, SpdLT appears in the lower display on the Speed Limit Edit Screen and on the initial Speed Measurement Screen.	24, 32
tt	The instrument's test tone is active. Used during the Scope Alignment Test. Appears in the upper display.	26

Adjusting the Aiming Reticle's Intensity

The in-scope aiming reticle has eight intensity settings from DIM (01) to BRIGHT (08).

1. Press the  button. The display should look similar to Figure #10. The factory default setting is "br 05" as shown in the figure.
2. Press the  button until the desired setting is achieved. It's easy to get the desired setting if you look through the scope while making the adjustment.
 - o Each time you press the button, the "br xx" value increases by 1.
 - o If you press the button while "br 08" is displayed, you will see "br 01" next.
3. Press the TRIGGER to return to the measurement mode that was most recently active.

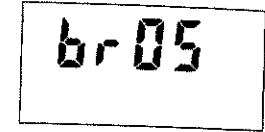



Figure #10

-  Powering OFF the instrument does not change this setting. The next time the instrument is powered ON, the setting will be the same.

Restoring Factory Default Settings



1. Verify that the TruSpeed is powered ON.
2. Simultaneously, press and hold the  button and the  button until "dEF CLEAR" appears on the screen. The display should look similar to Figure #11.
3. Release both buttons. The Speed Mode will be active and the Speed Measurement Screen will be displayed.



Figure #11

Listening to the TruSpeed

The TruSpeed emits a variety of beeps and tones during use. The sounds vary and depend on what the instrument is doing. The table below lists and explains each of the sounds.

Sound	Explanation
3 Low-Pitched and 1 High-Pitched Beeps	At Power ON.
Low-Pitched Growl	The instrument is attempting to lock onto a target.
1 Low-Pitched and 2 High-Pitched Beeps	The instrument was not able to complete the intended speed measurement due to an error. An error code will be displayed to indicate the nature of the error (page 15).
High-Pitched Triple Beep	The laser's return sensor detected interference from a light source such as a xenon headlight or laser jammer device. The speed reading is valid.
High-Pitched Oscillating Ring	Jam tone. The instrument's laser return sensor is being overwhelmed by interference from a light source such as a headlight or laser jammer device.
High-Pitched Single Beep	The instrument successfully completed the intended speed measurement.
	Speed Limit Edit Feature is active: (1) When editing the speed limit, the speed limit was stored. (2) During a speed measurement, the instrument successfully completed the intended measurement and <i>it was below the speed limit.</i>
Low-Pitched Double Beep	Speed Limit Edit Feature is active, when editing the speed limit, you entered an invalid speed limit (page 32).
High-Pitched Double Beep	Speed Limit Edit Feature is active: During a speed measurement, the instrument successfully completed the intended measurement and <i>it was above the speed limit.</i>
Low-Pitched Single Beep	At Power OFF.

Understanding Error Conditions

Although it's rare, error conditions can occur during a measurement attempt or in the system hardware. To make sure that you never get an erroneous speed reading, the TruSpeed monitors both the system hardware and the measurement. When the instrument detects an error condition, it displays an error code instead of a measurement.

Error Codes

Code	Explanation
E 01	Measurement Error - the target was out of range or was too close.
E 02	Measurement Error - insufficient data. The unit does not have enough data to measure speed. <i>Possible Cause:</i> early release of the TRIGGER or time-out.
E 03	Measurement Error - unstable targeting. Data is not stable enough to measure speed. <i>Possible Causes:</i> poor aiming or panning off the target.
	Measurement Error - low level of interference from a light source such as a xenon headlight.
E 07	Jam Detect - high level of interference from a light source such as a xenon headlight.
E 52	Temperature too cold. Stop operation.
E 53	Temperature too hot. Stop operation.
E 55 E57 E 56 E58	Calibration Errors. Please turn OFF unit and try again. If the same error is continuously repeated, please contact LTI. **
E 60	Memory failure. Please turn OFF unit and try again. If the same error is continuously repeated, please contact LTI. **
E 62	Receiver Failure. Please turn OFF unit and try again. If the same error is continuously repeated, please contact LTI. **
E 99	General System Failure. Please contact LTI. **

***See inside front cover for LTI contact information.*

RFI Considerations

The TruSpeed does not display a specific error message indicating the presence of radio frequency interference (RFI). The instrument's electronics have been designed for optimum RFI immunity. If RFI is present, the instrument displays an error code. The exact code depends on the level and nature of the RFI.

Section #2 - Speed Measurements

When you power ON the TruSpeed, the instrument will perform the Self Test. Figure #12 shows successful completion of the Self Test. See page 31 for more information about the Self Test.

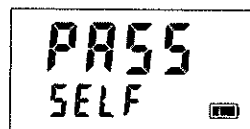

Figure #12

The next screen is automatically displayed and should look similar to Figure #13.

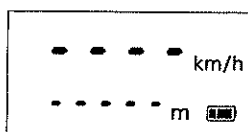

Figure #13

- The dashes that appear in the upper display indicate where the speed measurement will appear.
- "km/h" means the speed will be measured in kilometers per hour.
- The dashes that appear in the lower display indicate where the distance to the target vehicle will appear.
- "m" means the distance will be measured in meters.
- The Battery Icon indicates the approximate battery voltage level (page 9).

Taking a Sample Measurement

1. Ensure that the TruSpeed is powered ON and that the Speed Mode is active.
2. Use the sighting scope and aiming reticle to aim the instrument to a convenient target. An interior wall will do.
3. To fire the laser:
 - Press and hold the TRIGGER. The laser will fire after a short delay (about one-half of a second).
 - or-
 - Press the TRIGGER twice.
The 1st press turns on the in-scope aiming reticle.
The 2nd press takes the measurement.
4. Continue to press the TRIGGER and keep the instrument sighted on the target:
 - A low-pitched growl means that the instrument is attempting to lock onto the target.
 - 1 Low-Pitched and 2 High-Pitched Beeps mean that a measurement error occurred. An error code will be displayed (page 15).
 - A high-pitched single beep means that a speed was captured. The measured speed will be displayed on the LCD screen and will be projected in the scope, just below the aiming reticle.

After you release the TRIGGER, the instrument will display the most recent speed reading and the distance at which it was captured. The display screen will look similar to Figure #14. If you did not capture a speed, an error code will be displayed (page 15).

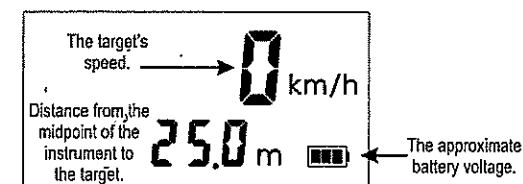

Figure #14

Choosing a Roadside Location

When choosing a spot on the side of the road for measuring moving vehicles, you will need to consider:

- Is the location safe?
- Do you have a clear line of sight?
- What is the approximate angle between the instrument's position and the target vehicle's direction of travel?
- What is the approximate distance to the target vehicles?
- How is the weather? Will you need to use the Weather Mode?

Line of Sight

Ideally, you should have a clear line of sight to the target vehicle.

- *If there is a momentary break in the beam*, the instrument will accumulate data and may be able to capture the target vehicle's speed. The instrument will display an error code if it cannot capture the target vehicle's speed.
- *If there is an extended break in the beam*, the instrument will display an error code.

The Cosine Effect

If the target vehicle is moving directly toward or away from you, the speed measured by the TruSpeed is identical to the vehicle's true speed. However, the instrument is usually set up on the side of the road for safety. This results in an angle between the instrument's position and the target vehicle's direction of travel. When the angle is significant, the measured speed is less than the target's true speed. The phenomenon is known as the cosine effect. Cosine is the trigonometric function that relates to this phenomenon.

The difference between the measured speed and the true speed depends upon the angle between the instrument's ideal position- the position where targets would be moving in direct line with the instrument- and its actual position.

- The larger the angle, the lower the measured speed.
- The effect always works to the motorist's advantage.
- Loosely speaking, the cosine effect is not significant as long as the angle remains small. The table below shows this effect.

Measured Speed by Angle: The Cosine Effect

Angle (degrees)	True Speed				
	50 km/h	70 km/h	90 km/h	110 km/h	130 km/h
	Measured Speed (km/h)				
0	50.00	70.00	90.00	110.00	130.00
1	49.99	69.99	89.99	109.98	129.98
3	49.93	69.90	89.88	109.85	129.82
5	49.81	69.73	89.66	109.58	129.50
10	49.24	68.94	88.63	108.33	128.02
15	49.30	67.62	86.93	106.25	125.57
20	46.98	65.78	84.57	103.37	122.16
45	35.36	49.50	63.64	77.78	91.92
90	00.00	00.00	00.00	00.00	00.00

The cosine effect decreases as the range to the target vehicle increases.

- At the maximum range of the instrument, the vehicle is so far away that the angle between it and the instrument is very small indeed. The instrument's perception of the target's speed is identical to its true speed.
- As the vehicle approaches, the angle increases until it becomes large enough to affect the measurement.

- **i** To minimize the cosine effect, keep the angle small. Set up the instrument as close to the road as possible without creating safety risks, and target down the road at ranges sufficient to keep the angular difference small.

The table below shows acceptable parameters for minimizing the cosine effect. The chart indicates the percentage of true speed measured, given the distance from the roadway and the distance from the target vehicle. To find a target's measured speed, multiply the true speed by the number in the chart.

Distance off the roadway (meters)	Range to Target Vehicle				
	30 m	100 m	150 m	300 m	600 m
	<i>fraction of the True Speed that will be measured</i>				
3	.9950	.9995	.9998	.9999	1.0000
10	.9682	.9950	.9987	.9997	.9999
15	.8660	.9886	.9950	.9987	.9997
30	.0000	.9539	.9798	.9950	.9987
60	.0000	.7999	.9165	.9798	.9950

The diagonal created by the boldface numbers indicates the boundary between acceptable and unacceptable parameters.

- Numbers *above* the diagonal are acceptable margins of error.
- Numbers *below* the diagonal are unacceptable margins of error.

Remember that the cosine effect is always in the motorist's favor.

- **i** As a general rule, do not exceed 1 meter off the road for every 10 meters shooting down range to the targets. If target vehicles will be 150 meters down the road, set up no more than 15 meters off the road.

Measuring a Moving Vehicle

1. Ensure that the TruSpeed is powered ON and that the Speed Mode is active.
2. Use the aiming reticle to aim the instrument at the target vehicle's license plate area and press the TRIGGER.
3. Continue to press the TRIGGER and keep the instrument sighted on the target.
 - o A low-pitched growl means that the instrument is attempting to lock onto the target.
 - o A low-pitched beep means that a measurement error occurred. An error code will be displayed.
 - o A high-pitched single beep means that a speed was captured. The measured speed will be displayed on the LCD and projected in the scope just below the aiming reticle.

While the instrument is attempting to lock onto the target, as long as the TRIGGER is kept pressed, it will retry the speed measurement.

- In this mode, the instrument will attempt to lock onto the target for up to 5 seconds. Information is accumulated until it gets a good measurement or generates an error code.
- Consequently, it is very important that the aiming point on the target remain constant for the entire measurement time. If you move the instrument off the aiming point, it will generate an error code instead of capturing a speed reading.

After you release the TRIGGER, the instrument will display the most recent speed reading and the distance at which it was captured or an error code. When the most recent speed reading is displayed, the display screen will look similar to Figure #15.

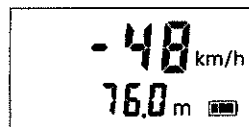

Figure #15

- The speed displays as a *negative number* if the target was going away from you when it was measured.
- The speed displays as a *positive number* if the target was approaching you when it was measured.

Using the Weather Mode

Moisture is reflective. Weather such as rain, snow, or fog can make it difficult for the laser to receive signals back from the target. This is especially true when you are trying to capture speeds at close range. The TruSpeed includes a built-in Weather Mode that is an alternate speed measurement mode. When the Weather Mode is active, the factory-defined gate setting increases the instrument's minimum range from 15 meters to 61 meters. Increasing the minimum range ensures that the laser only acquires targets beyond the range where weather affects the laser's ability to capture a speed reading.

When the Weather Mode is active:

- The Weather Mode indicator appears in the lower left corner of the LCD Screen.
- Targets must be a distance greater than 61 meters.
- The instrument's maximum range is not changed.
- Other than the above items, the TruSpeed operates the same as when the Speed Mode is active and the Weather Mode is not active.

To activate the Weather Mode.

1. Ensure that the TruSpeed is powered ON and that the Speed Mode is active.

2. Press the  button. The display should look similar to Figure #16.

3. Use the aiming reticle to aim the instrument at the target vehicle's license plate area and press the TRIGGER.

4. Continue to press the TRIGGER, and keep the instrument sighted on the target:

- o A low-pitched growl means that the instrument is attempting to lock onto the target.
- o A low-pitched beep means that a measurement error occurred. An error code will be displayed.
- o A high-pitched single beep means that a speed was captured. The measured speed will be displayed on the LCD and projected in the scope just below the aiming reticle.

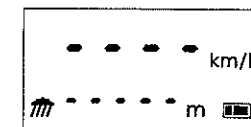

Figure #16

While the instrument is attempting to lock onto the target, as long as the TRIGGER is kept pressed, it will retry the speed measurement.

- In this mode, the instrument will try up to 5 seconds. Information is accumulated until it gets a good measurement or generates an error code.
- Consequently, it is very important that the aiming point on the target remain constant for the entire measurement time. If you move the instrument off the aiming point, it will generate an error code instead of capturing a speed reading.

After you release the TRIGGER the instrument will display the most recent speed reading and the distance at which it was captured or an error code. When the most recent speed reading is displayed, the display screen will look similar to Figure #17.



Figure #17

Using the Continuous Mode

Continuous Mode is an alternate speed measurement mode. If you wish to take several successive readings on a target, you can put the instrument in Continuous Mode. In this mode, the instrument takes and displays one reading after another, and continues to take and display readings as long as you hold down the TRIGGER. Release the trigger, and the instrument finishes its latest reading and stops. If an error code is shown when you release the trigger, the instrument will display either the most recent speed reading, or, if the error code has persisted for several tries, the error code will remain.

When the Continuous Mode is active:

- The Continuous Mode indicator appears in the middle left side of the LCD Screen.
- For the best results, do not try to use Continuous Mode to target one vehicle after another. When you wish to change targets, release the trigger, aim to the new target, and retrigger.

To activate the Continuous Mode:

1. Ensure that the TruSpeed is powered ON and that the Speed Mode is active.
2. Press the  button. The display should look similar to Figure #18.
3. Use the aiming reticle to aim the instrument at the target vehicle's license plate area and press the TRIGGER.
4. Continue to press the TRIGGER and keep the instrument sighted on the target:

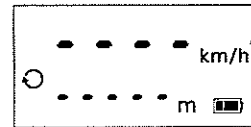

Figure #18

- A low-pitched growl means that the instrument is attempting to lock onto the target.
- A low-pitched beep means that a measurement error occurred. An error code will be displayed.
- A high-pitched single beep means that a speed was captured. The measured speed will be displayed on the LCD and projected in the scope just below the aiming reticle.

While the instrument is attempting to lock onto the target, as long as the TRIGGER is kept pressed, it will retry the speed measurement.

- In this mode, the instrument will try up to 5 seconds. Information is accumulated until it gets a good measurement or generates an error code.
- Consequently, it is very important that the aiming point on the target remain constant for the entire measurement time. If you move the instrument off the aiming point, it will generate an error code instead of capturing a speed reading.
- The instrument will take and display one reading after another as long as you hold down the TRIGGER.

After you release the TRIGGER the instrument will display the most recent speed reading and the distance at which it was captured or an error code. When the most recent speed reading is displayed, the display screen will look similar to Figure #19.

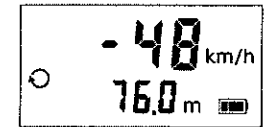

Figure #19

Optional Jam Detect Feature

- ① Your TruSpeed may not include the Optional Jam Detect feature. It is a factory-defined option that is set when the instrument is shipped. The TruSpeed includes hardware-based laser jammer detection. Jam Detect is an integrated software feature that provides, (1) Jammer Defeat, (2) Jammer Detection, and then (3) emits the jam tone to alert the user.

The LTI 20/20 TruSpeed contains advanced circuitry and algorithms that allow the instrument to determine if a laser jammer is being used. The JAM tone (page 14) indicates that the instrument is being flooded by a light source. There are two possible situations:

- You are targeting a strong light source such as xenon headlights.
- OR-
- A targeted vehicle is employing a laser jammer.

Regardless of the level of interference, you will never get an erroneous speed reading.

- If the laser jammer uses "smart" technology, you will hear the jam tone and the measured speed will flash.
- If the laser jammer does not use "smart" technology or if the interference is from a light source other than a laser jammer:
 - At a low level of interference, you will hear the jam tone and a speed may be captured or an E03 error code may be displayed.
 - At a high level of interference, you will hear the jam tone and an E07 error code will be displayed.

Optional Local Speed Limit Edit

- i** Your TruSpeed may not include the Local Speed Limit Edit feature. It is a factory-defined option that is set when the instrument is shipped.

The Local Speed Limit Edit feature allows you to enter the local speed limit into the TruSpeed. For information about entering the local speed limit, see page 32. Once you have entered the local speed limit:

- "SPdLt" will appear in the lower display on the initial Speed Measurement Screen as Figure #20 shows.
- The instrument will emit a high-pitched single beep when it successfully completes a speed measurement that is less than the local speed limit.
- The instrument will emit a high-pitched double beep when it successfully completes a speed measurement that is equal to or above the local speed limit.

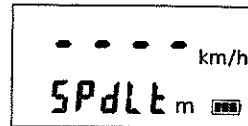

Figure #20

Section #3 - Test Mode and Instrument Tests

The Test Mode includes 7 options and allows you to verify the TruSpeed's mechanics. These options include:

- Display Integrity Test
- Scope Alignment Test
- Delta Distance Test
 - Fixed Distance Zero Velocity Test
- Instrument Self Test
- Local Speed Limit Edit
- Model and Firmware Version Number Display
- Serial Number Display

Display Integrity Test

The Display Integrity Test allows you to verify that all display segments are operating. LTI suggests that you do this test periodically.

1. Ensure that the TruSpeed is powered ON.
2. Press the button. The display should look like Figure #21.
 - Compare the instrument's LCD to Figure #21 (A).
 - Compare the instrument's in-scope Heads Up Display to, figure #21 (B). The lower portion of the display will flash 5 times. If the display times out before you can complete this test, press the button repeatedly until this screen is displayed again.
3. If any segment fails to display, contact Laser Technology, Inc. to arrange for repair. See the inside front cover for LTI contact information.

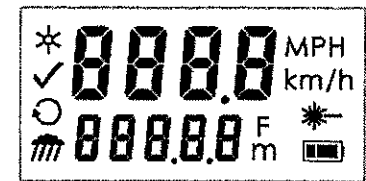

(A)

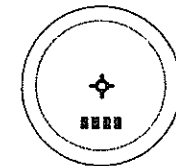

(B)

Figure #21

- i** The display integrity is also tested each time the unit is powered ON. However, the results are only briefly displayed before the results of the Self Test are displayed.

Scope Alignment Test

Scope alignment is set at the factory when the instrument is shipped. A heavy blow is the only reason that the scope might ever go out of alignment. LTI suggests that you do this test periodically.

The Scope Alignment Test uses sound to indicate when the scope is on-target.

1. Select a target. Choose a prominent target with well-defined horizontal and vertical edges. A telephone pole is an excellent choice.
 - Recommended distance to target: 200 meters.
 - The target's reflective qualities and distance should be such that you can clearly hear a change in pitch of the test tone as you pan the instrument over the edges of the target.
 - Make sure there is nothing behind the target that the instrument might detect, so you know without a doubt that any change in pitch is due strictly to the target.
2. Ensure that the TruSpeed is powered ON.
3. Press the button two times to activate the Test Tone display screen. It should look similar to Figure #22.
4. Scan the target. Press and hold the TRIGGER while panning the instrument across the target. The tone changes pitch when the instrument acquires the target. The highest pitch - the on-target tone - should occur when the in-scope aiming reticle is centered on the target. Scan the target both horizontally and vertically.
 - *If the frequency drops off at equal distances from the center of the aiming reticle, the instrument needs no adjustment.*
 - *Otherwise, contact Laser Technology, Inc. for assistance with re-aligning the scope. See the inside front cover for LTI contact information.*

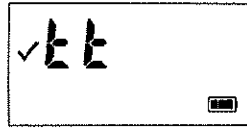

Figure #22

- i** When checking vertical alignment to a close target, be aware of the offset between the center of the scope and the center of the transmit lens, which is 5 centimeters.

Instrument Confidence Checks

There are several ways to verify the measurement accuracy of a Lidar instrument. You can verify it directly by measuring the speed of an object traveling at a known speed, but this is seldom practical. The nature of Lidar is such that it cannot be tricked by a vibrating object, such as a tuning fork, into displaying a velocity. For these reasons, LTI has designed the Fixed Distance Zero Velocity Test and the Delta Distance Test. LTI suggests that you do one of these tests each time the instrument is taken on duty.

These tests verify the accuracy of the two key elements of Lidar speed measurement:

- Precise time measurements
- Ability to make mathematical calculations

When setting up an area for these tests, LTI recommends:

- Permanently installing the test area in a convenient location. The test area must establish a permanent, known distance between a shooting mark and a target (Fixed Distance Zero Velocity Test) or between a shooting mark and two targets (Delta Distance Test).
- Using a metal tape to measure the distance; this will ensure that the measurement is accurate.

Other considerations:

- The shooting mark is where you stand to do the test, and it can be an "X" painted on the pavement.
- A target can be any flat, permanent structure—a sign or wall, for example—painted with a bull's eye or other aiming point.
- The shooting mark and the target must form a straight line.
- The manner in which you stand and hold the instrument both affect the test measurements. For exact readings, carefully hold the instrument so center of the TruSpeed is directly over the middle of the X.

Fixed Distance Zero Velocity Test

- ❗ The Fixed Distance Zero Velocity Test is not one of the options included in the Test Mode. In order to perform the Fixed Distance Zero Velocity Test, the Speed Mode must be active.

The Fixed Distance Zero Velocity Test requires one target:

- LTI recommends that the target should be 60 meters from the shooting mark. See Figure #23. If there is not enough space available, that specific distance is not crucial. However, the distance between the target and the shooting mark must be a multiple of 1 meter, not a fraction of a meter.

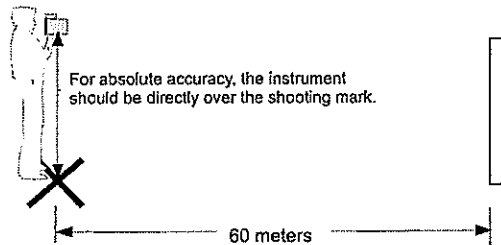

Figure #23

1. Stand on the shooting mark.
2. Ensure the TruSpeed is powered ON and that the Speed Mode is active.
3. Use the aiming reticle to aim at the target.
4. Press the TRIGGER.
5. Check the display.

- The speed reading should be zero km/h. A reading of zero verifies the timing accuracy of the instrument and is identical in nature to an accurate velocity reading of a vehicle moving at any speed.
- The displayed distance should read from 59.8 to 60.2 meters if your fixed distance was 60 meters.



Figure #24

- ❗ • Speed accuracy = ± 2 km/h.
- Distance accuracy = ± 15 cm or 0.2 meters (rounded).
- If you need assistance, contact Laser Technology, Inc. See the inside front cover for LTI contact information.

Delta Distance Test

- ❗ Your TruSpeed may not include the Delta Distance Test. It is a factory-defined option that is set when the instrument is shipped.

The Delta Distance Test requires two targets. LTI recommends that the first target should be 45 meters from the shooting mark, and the second should be 55 meters from the mark. See Figure #25. If there is not enough space available, that specific distance is not crucial. However, the distance between the target and the shooting mark must be a multiple of 1 meter, not a fraction of a meter.

Refer to Figure #25 as a guide for positioning the targets and the shooting mark.

1. Install the farther target.
2. Measure 55 meters to the shooting mark and mark the shooting spot.
3. Measure from the shooting mark 45 meters to the second target.
4. Mark that spot and install that target.

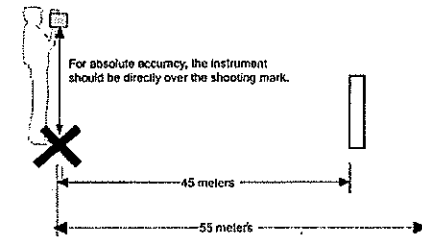







Figure #25

To conduct the test, refer to the table below.

Action	Results
1. Stand on the shooting mark. 2. Power ON the TruSpeed and press the <input checked="" type="checkbox"/> button 3 times until the message -d1- appears in the upper display.	
3. Aim to the far target and press the TRIGGER. 4. Check the display. If necessary, you may repeat step #3.	
5. Press the <input checked="" type="checkbox"/> button. The message -d2- appears in the upper display.	
6. Aim to the near target and press the TRIGGER. 7. Check the display. If necessary, you may repeat step #6.	
8. Press the <input checked="" type="checkbox"/> button. The screen displays the difference between the two distances 10 meters ±30 cm.	
<i>If the targets are shot in reverse order, the display is the same, but the difference appears as a negative number</i>	

- If the difference is 10 meters, the displayed distance should be 9.7 to 10.3 meters.

i If you need assistance, contact Laser Technology, Inc. See the inside front cover for LTI contact information.

Instrument Self Test

Just like when the instrument is powered ON, during the Self Test the microcontroller interrogates the system electronics.

To complete the Self Test:

1. Press the button repeatedly until the screen display looks similar to Figure #26.
2. Press the TRIGGER to complete the Self Test. Figure #27 shows an example of all tests proving positive.
 - If all tests do not prove positive, the appropriate error code will appear in the upper display (see page 15).





Figure #26



Figure #27

i If the instrument fails the Self Test:

1. Press the  button to power OFF the TruSpeed.
2. Press the  button to once again power ON the TruSpeed and repeat the Self Test.
3. Contact LTI if the error repeats and you need assistance. See the inside front cover for LTI contact information.

Optional Local Speed Limit Edit

- Your TruSpeed may not include the Local Speed Limit Edit feature. It is a factory-defined option that is set when the instrument is shipped.

To display the Speed Limit Edit Screen, press

the button repeatedly until the screen display looks similar to Figure #28. The current value associated with the local speed limit appears in the upper display. In this example the local speed limit is 30 km/h.

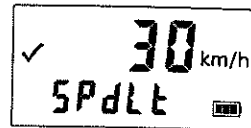

Figure #28



Figure #29

1. Press the button 5 times. The initial screen should look similar to Figure #28.
 2. Press the button to edit the local speed limit. The right-most digit will flash as shown in Figure #29.
- Press the button to add 1 value of the flashing digit.
 - Press the button to subtract 1 from the value of the flashing digit.
 - Press the button to move to the digit to the left of the flashing digit.
 - Valid Values: 0 to 322 km/h.
 - Entering a value of 0 km/h disables this feature.
 - Press the button to store the value as the local speed limit.
 - *If you entered a valid value*, the instrument will emit a single beep and store the value as the local speed limit.
 - *If you entered an invalid value*, the instrument will emit a double beep and the previous value will be reset.
- When factory default settings are restored (page 13), the Local Speed Limit Edit value is set to 0 km/h.
 - See page 24 for information about taking speed measurements after entering a value other than zero for the Local Speed Limit.

Model and Firmware Version Number Display

To display the model number and firmware version number of your TruSpeed, press

the button repeatedly until the model number and firmware version is displayed. The display should look similar to Figure #30. The model number appears in the upper display and the firmware version number appears in the Lower Display. In this example, the model number is "100L" and the firmware version number is "1.10".



Figure #30

- In this example:

- The 'L' that appears as the last character in the upper display indicates that this particular TruSpeed includes the optional Long Range Feature.
- The 'd' that appears as the first character in the lower display indicates that this particular TruSpeed includes the optional Jam Detect feature.

Serial Number Display

To display the serial number of your TruSpeed,

press the button repeatedly until the serial number is displayed. The display should look similar to Figure #31. The serial number has 6 digits and appears in the upper and lower display. In this example, the serial number is "000001".



Figure #31

Section #4 - Maintenance

Operating Temperature

The instrument is rated for a temperature range of -30° C to +60° C. Do not operate the instrument in temperatures outside that range.

Moisture and Dust Protection

The TruSpeed is sealed to provide protection from normally encountered field conditions. It is protected from dust and light moisture.

Shock Protection

The TruSpeed is a precision instrument and should be handled with care. It will withstand a reasonable drop shock. If you drop the instrument, check the scope alignment (page 26) before using the instrument for speed measurement.

Cleaning and Storage

Clean the instrument after each use. Check for the following:

- *Excess moisture.* Towel off excess moisture and air dry the instrument at room temperature.
- *Exterior dirt.* Wipe exterior surfaces clean. Use isopropyl alcohol to remove dirt and fingerprints from the scope exterior.
- *Dirty lenses.* Use a lens brush to remove surface dust and loose particles from the front panel lenses. To clean a lens, moisten it with lens cleaning solution and wipe it with a clean cloth or lens tissue.
- *Batteries.* If you won't be using the instrument again soon, remove the batteries before storing it.

Caring for the Scope

Do not attempt to lubricate the scope. It is sealed from within using o-rings and special compounds. All seals are permanent and require no maintenance.

Use a lens brush to remove surface dust and loose particles. To clean a lens, moisten it with lens cleaning solution and wipe it with a clean cloth or lens tissue.

Checking the Screen Display

The instrument provides a method of verifying the display integrity. For more information, see page 25.

Restoring Factory Default Settings

See page 13.

Section #5 - Serial Data Interface

The TruSpeed serial interface uses RS-232 +/-12V signal levels and data format. Figure #32 shows the pin-out assignments for the TruSpeed's serial port.

Data Format

TruSpeed serial data format is similar to that of the Laser Technology Marksman 20/20 and UltraLyte speed detection instruments. All data values are available at the serial port after each measurement.

Format Parameters

- 115200 BPS
- 1 stop bit
- 1 start bit
- no parity
- 8 data bits

Download Instructions

The instructions below are provided for general information only. Specific steps may vary, depending upon your data collection program.

1. Connect the TruSpeed to the PC, Pocket PC, etc.
2. Start the data collection program on the PC and adjust settings to match format parameters (115200 baud, 8 data bits no parity, 1 stop bit).
3. Power ON the TruSpeed and verify that the speed mode is active.
4. Take the desired measurement.

Remote Trigger

It is possible to remotely trigger the TruSpeed and take measurements using an external computer, data collector, or switch closure. Remote triggering is accomplished by providing an open collector closure to ground or an active low TTL or RS232 level signal to the 'trigger' pin on the serial connector. This option requires a special order download cable that connects the remote trigger signal from the TruSpeed to the 'RTS' output signal of a computer's serial port.

When using a serial cable with a remote trigger connection, care must be taken in controlling the state of the RTS signal from the host computer. Often times the default state of the RTS signal will be low, causing an inadvertent trigger of the TruSpeed. Since the remote trigger signal is treated the same as a button press on the TruSpeed, holding the signal low is identical to holding down a button, which prevents a response to any additional keys that are pressed.

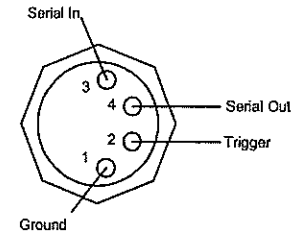

Figure #32

Requests

Firmware Version ID Request

\$ID<CR><LF>

- \$ID** The request identifier.
- <CR>** A carriage return.
- <LF>** An optional line feed character.

Instrument response:

\$ID,TSmodel-versionid,date,csum<CR><LF>

- \$ID** Message identifier.
- TSmodel** The TruSpeed model (TS100).
- versionid** The version ID of the internal firmware (preceded by a hyphen).
- date** The effective date of the firmware version (MMM DD YYYY format).
- csum** 32-bit checksum.

Example Version ID Messages

Request: \$ID<CR><LRF>
Response: \$ID,TS100-1.10-4,Mar 30 2008,9235FA06*3AAA

Serial Number Request

\$SN<CR><LF>

- \$SN** The request identifier.
- <CR>** A carriage return.
- <LF>** An optional line feed character.

The instrument's response is as follows:

\$SN,SerialNum*csum

- \$SN** Message identifier.
- SerialNum** TS followed by 6 digit serial number.
- *csum** 8-bit checksum.

Example Version ID Messages

Request: \$SN<CR><LRF>
Response: \$SN,TS000004*4399

Speed / Range Data Message Format

Speed,Range,Sunits,Runits*csum<CR><LF>

- Speed** The speed measurement. Legal values are 000 to 322 Km/h. If the target was departing when the measurement was taken, the number will be preceded by a minus sign.
- Range** The range measurement. Standard legal values: 0000.0 to 650.0 (unsigned). Long Range legal values: 0000.0 to 1200.0 (unsigned).
- Sunits** Speed units (K = km/h).
- Runits** Range units (M = meters).
- *csum** 8-bit checksum.
- <CR>** Carriage return.
- <LF>** An optional line feed character.

Example Speed/Range Messages

\$SP,80,213.8,K,M*493D

- i** If a measurement error occurs, the speed and range values are replaced by an error code in the form *\$Er,xx*csum*, where *xx* is the error code. For more information about Error Codes, see page 15.

Section #6 - Specifications

Weight:	1.25 kg (with batteries)
Size:	20 x 8 x 30 cm
Acquisition Time:	0.33 seconds
Speed Measurement Range:	±322 km/h
Speed Accuracy:	±2 km/h
Minimum Range:	
Speed Mode:	15 meters
Weather Mode:	61 meters
Continuous Mode:	15 meters
Maximum Range:	
Standard:	650 meters
Long Range:	1,200 meters (optional feature)
Range Accuracy:	±15 cm
Range Resolution:	0.1 meter
Beam Divergence:	2.5 milliradians nominal
Laser Wavelength:	905 nanometers nominal
Temperature Range:	-30° C to +60° C
Power:	Two alkaline, NiCad, or NiMH rechargeable C-cell batteries providing up to 25 hours of cordless operation.
Eye Safety:	FDA Class 1 (CFR 21)
Environment:	Water resistant NEMA 4 and IP 55
Construction:	Composite Polycarbonate Outer Shell Aluminum Internal Chassis

Section #7 - Troubleshooting Tips

What You Will See	Required Action
Unit powers OFF by itself. -or- No power at all.	<ul style="list-style-type: none"> Verify that the batteries are installed correctly. Replace the batteries. Keep in mind that the instrument automatically powers OFF if there is no instrument activity for a period of 15 minutes.
The in-scope aiming reticle is not visible.	<ul style="list-style-type: none"> Press the TRIGGER to activate the aiming reticle. Press the  button to increase the intensity of the aiming reticle. Adjust the polarizing filter.
E01 error code. No range or speed readings.	<ul style="list-style-type: none"> Can you measure to a wall that is about 15 meters away? Check the scope alignment. Restore the factory defaults. When measuring a short range to a small target, aim slightly above the target.
Erroneous readings/not repeatable.	<ul style="list-style-type: none"> Do you have a clear line of sight? Check the scope alignment. Is it raining or foggy. If yes, is the Weather Mode active? If not, turn it ON. Keep in mind that the minimum range will be 61 meters. When measuring a short range to a small target, aim slightly above the target.
Limited Range.	<ul style="list-style-type: none"> Do you have a clear line of sight? Rain or fog will reduce the unit's maximum range. Is the Weather Mode active? If not, turn it ON. Keep in mind that the minimum range will be 61 meters. Keep in mind that acquiring a target through glass will reduce the unit's maximum range. Make sure the lens is clean. Check the lens for scratches.
Difficult to acquire target while aiming through windshield.	<ul style="list-style-type: none"> Is the Weather Mode active? If not, turn it ON. Keep in mind that the minimum range will be 61 meters. If the windshield is bubble-shaped, shoot through the center of the windshield.
Difficult to acquire target while aiming through rain or snow.	<ul style="list-style-type: none"> Is the Weather Mode active? If not, turn it ON. If not, turn it ON. Keep in mind that the minimum range will be 61 meters.

Section #8 - Glossary

- beam divergence:** The tendency of a laser beam to expand in diameter as it moves away from the source, measured in milliradians (mrad).
- Continuous Mode:** Alternate speed measurement mode. Allows you to take several successive readings of a target vehicle. Re-trigger for each new target. See page 22.
- Delta Distance Test:** Optional Feature. Uses two measurements each to a known distance to verify the measurement accuracy of the TruSpeed. See page 29.
- Display Integrity Test:** Allows you to verify that all segments of the LCD screen are operating. See page 25.
- Fixed Distance Test:** Uses one measurement to a known distance to verify the measurement accuracy of the TruSpeed. See page 28.
- laser:** **Light Amplification by Stimulated Emission of Radiation.**
- lidar:** A device that is similar in operation to radar, but emits pulsed laser light instead of radio waves.
- microcontroller:** The computer processor that controls all of the functions of the TruSpeed.
- Receive Lens:** Located on the front panel of the TruSpeed, it is the bottom lens and receives the signals back from the target and then feeds the signal information to the microcontroller.
- reticle:** A scale located in the sighting scope that helps you aim to your target. It is visible when the TruSpeed is powered ON. You may need to press the TRIGGER to see the reticle. See page 5.
- Transmit Lens:** Located on the front panel of the TruSpeed, it is the top lens and transmits the infrared laser signals.
- Weather Mode:** Alternate speed measurement mode. The laser only acquires targets that are beyond the range where weather affects the laser's ability to capture a speed reading. Targets must be at a distance greater than 61 meters. See page 21.
- Zero Velocity Test:** See *Fixed Distance Test*.

Index

- A**
- acquisition time 38
 - adjustment ring filter 5
 - aiming reticle 5
 - brightness 13
 - not visible 39
- B**
- Backlight
 - button 6
 - bAtt CHAng 9, 12
 - batteries
 - inserting 8
 - battery
 - display indicator 9, 11
 - voltage level 9
 - Battery Release 4, 8
 - Battery Tube 4, 8
 - baud rate 35
 - beam divergence 38, 40
 - beeps 14
 - br:xx 12
 - brightness
 - of the aiming reticle 13
 - Brightness Control
 - button 6
 - buttons 6
- C**
- cleaning 34
 - confidence checks 27
 - construction 38
 - Continuous Mode 22, 40
 - button 6
 - display indicator 11
 - cosine effect 18
 - minimizing 19
- D**
- d1- 12, 30
 - d2- 12, 30
 - data format 35
 - DEF CLEAR 12, 13
 - Delta Distance Test 29, 40
 - results 30
 - Display Backlight 6
 - display indicator 11
 - display indicators 11
 - Display Integrity Test 25, 40
 - download instructions 35
 - drop shock 34
 - dust protection 34
- E**
- E xx 12
 - environment 38
 - error codes 15
 - serial data 37
 - error conditions 15
 - eye safety 3, 38
- F**
- factory defaults
 - how to restore 13
 - filter 5
 - filter adjustment ring 5
 - firmware version 33, 36
 - Fixed Distance Zero Velocity Test 28, 40
 - format parameters 35
 - front panel 4
- H**
- Handle / Battery Compartment 4

I
ID request 36

J
Jam Detect 23
jam tone 14

K
keypad 4

L
laser 40
Laser Fire
display indicator 11
laser jammer detection 23
laser wavelength 38
LCD backlight 6
LCD Screen 4, 5, 11
lenses 5
lidar 40
limited range 39
line of sight 18
lower display
LCD display 11

M
maximum range 38
measured speed 18
microcontroller 40
minimum range 38
Weather Mode 21
moisture protection 34

N
negative value
speed display 20
no power 39

O
OFF 10
ON 10
operating temperature 3, 34

P
panels
front and rear 4
PASS 12, 31
polarizing light filter 5
positive value
speed display 20
power 38
power OFF interval 10
Power ON/OFF button 6
powering
OFF 10
ON 10

R
range 38
accuracy and resolution 38
Range Units
display indicator 11
rear panel 4
Receive Lens 4, 5, 40
remote trigger 35
restore factory defaults 13
reticle 5, 40
RFI considerations 15
roadside location
how to choose 17

S
safety 3
scope
caring for 34
Scope Alignment Test 26
SELF 12
Self Test 31
serial number
display 33
request 36
serial port 4, 35
shock protection 34
Shoulder Stock 7
Shoulder Stock Attachment Point 4
Shoulder Stock Release 4
Sighting Scope 4, 5
size 38
SN 12
sounds 14
speaker 4
specifications 38
speed accuracy 38
speed measurements
Continuous Mode 22
how to take 17
LCD screen 16
moving vehicle 20
negative value 20
range 38
Weather Mode 21
Speed Mode 16
button 6
Speed Units
display indicator 11
storage 34

T
temperature range 3, 38
Test Mode 25
button 6
display indicator 11
test tone 26
tones 14
Transmit Lens 4, 5, 40
TRIGGER 4
troubleshooting tips 39
true speed
percentage measured 19
tt 12, 26

U
Unit powers OFF 39
upper display
LCD display 11

V
views
of the TruSpeed 4

W
Weather Mode 21, 40
button 6
display indicator 11
weight 38
windshield
aiming through 39

Z
Zero Velocity Test
see Fixed Distance Test

NOTES:

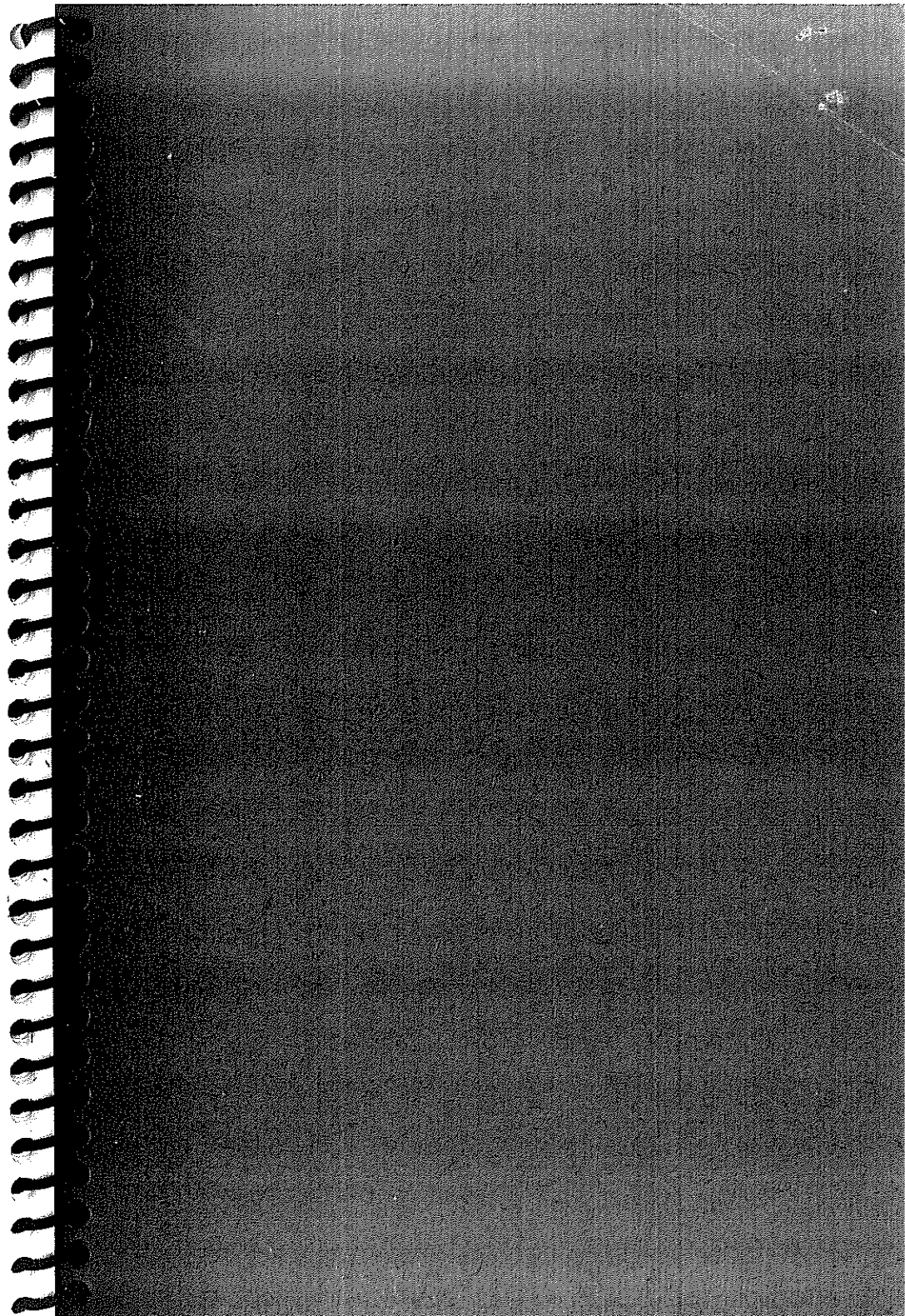

Certificate of Calibration

This certifies that the LTI 20-20 TruSpeed™ Speed Detection Instrument listed below has been thoroughly tested and meets or exceeds all manufacturer specifications.

Serial Number: TS001641
Calibration Date: Feb 02, 2009
Calibration Tech(s): V. Deslo
M. Southard
Laser Power: 90µW nominal
Beam Divergence: 2.5 mrad nominal
Speed Accuracy: ±1 mph or ±2 kph
Range Accuracy: ±6 in or ±15 cm
Scope Alignment:
Field Test:

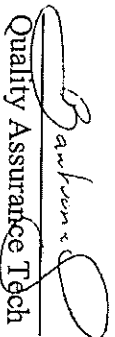
Quality Assurance Tech

Feb 03, 2009
Certification Date



Measurably Superior

7070 South Tucson Way
Centennial, CO 80112 USA
Phone: 1-303-649-1000
Fax: 1-303-649-9710
Web Site: www.lasertech.com

Part Number: 0144803 Rev. 3 July 2008